

2 ΧΡΟΝΙΑ ΕΓΓΥΗΣΗ

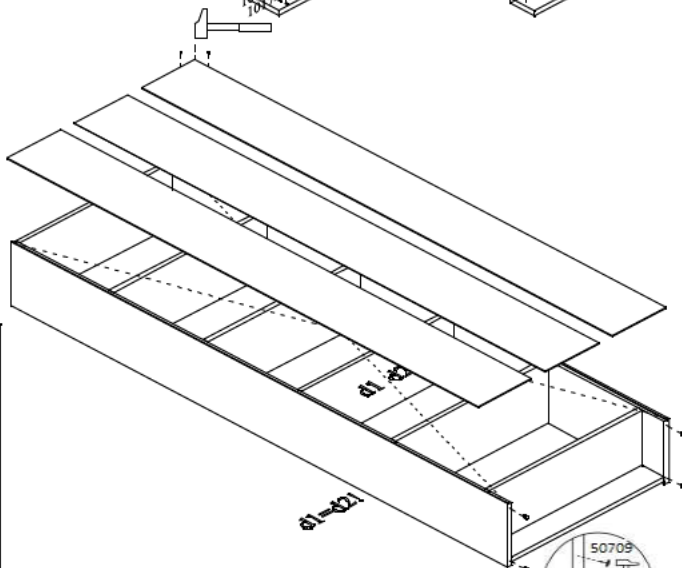

A	1810x220	1/1
B	1810x220	1/1
C	6x 558x216	1/1
D	558x80	1/1
E	3x 193x1720	1/1

8x 10174	16x 10013	8x 50317	2x 3,5x16 10001
12x 50332	4x 50709	60x 10033	
1x 6X50 10060	1x 4x50 10009	1x 30x30 50421	

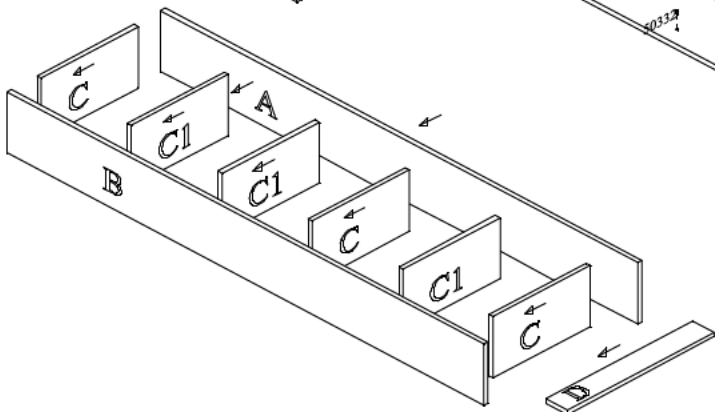
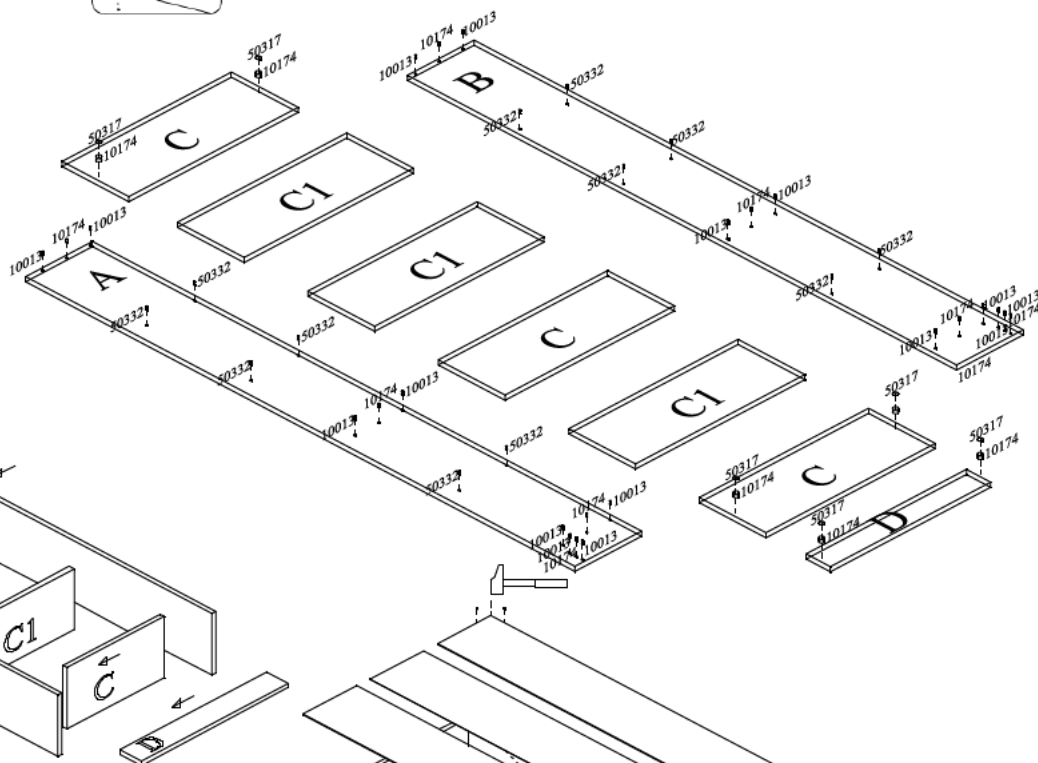
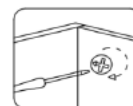
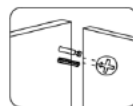
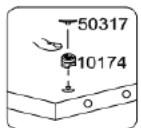
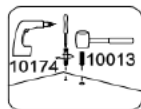
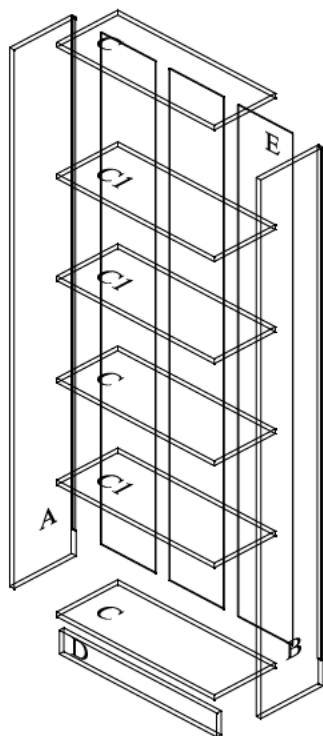

ΑΠΑΡΑΙΤΗΤΗ Η ΣΤΗΡΙΞΗ ΣΤΟΝ ΤΟΙΧΟ

