

2 YEARS WARRANTY
2 ΧΡΟΝΙΑ ΕΓΓΥΗΣΗ
2 ГОДИНИ ГАРАНЦИЯ

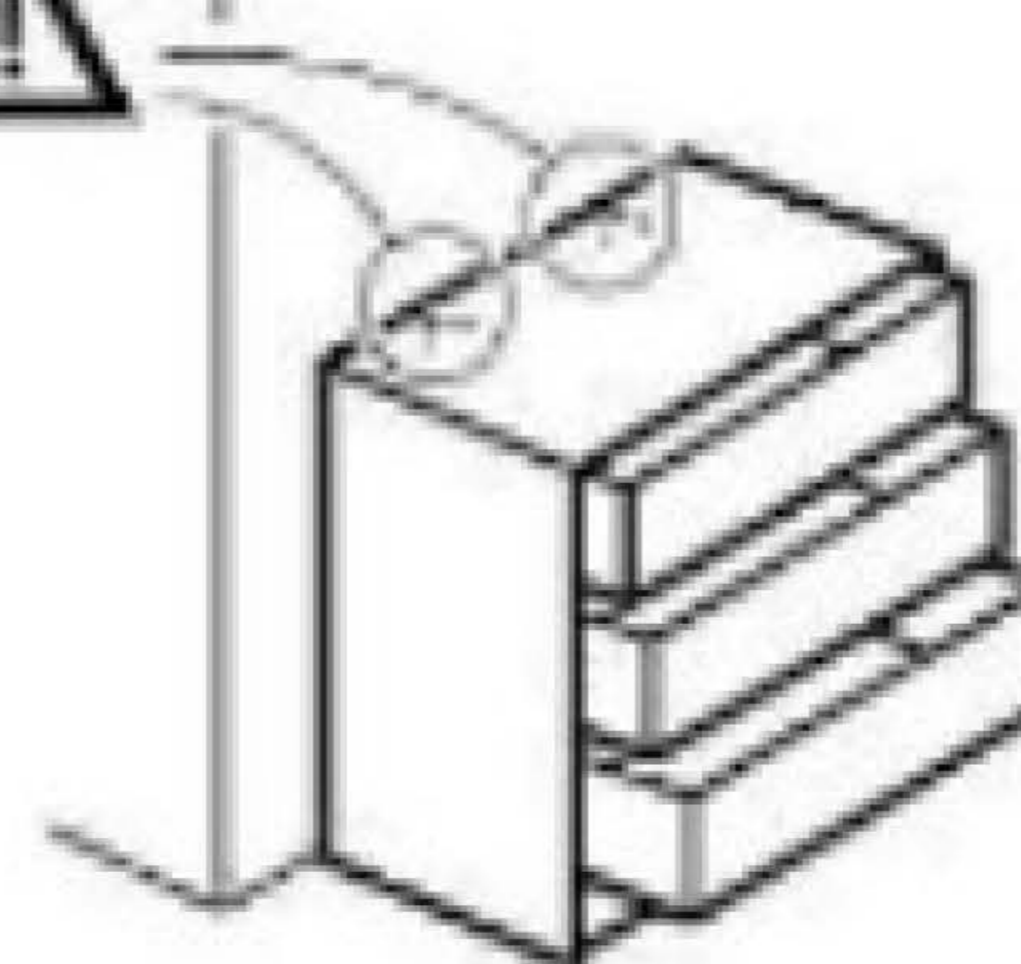









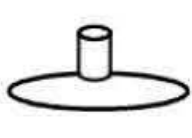

ΑΠΑΡΑΙΤΗΤΗ Η ΣΤΗΡΙΞΗ ΣΤΟΝ ΤΟΙΧΟ

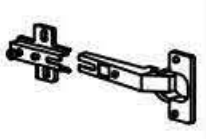
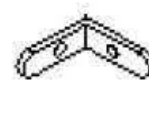

MOUNTING TO THE WALL IS
REQUIRED
НЕОБХОДИМО Ε
ЗАХВАЩАНЕ ΚΨΜ ΣΤΕΝΑΤΑ

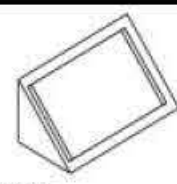
A	968x500	2/3
B	2000x500	1/3
C	2000x500	1/3
D	968x500	2/3
E	968x500	2/3
F	2x80x968	2/3
G	2x1915x496	1/3
H	2x1915x497	1/3

16X  10174	19X  10013	16X  50317	6X  50709
6X  40102	1X 30x30  50421	90X  10033	2X  6002
40X 3,5x16  10001	2X  50011	2X  50012	1X 6x50  10060
1X 4x50  10009			

