













ASSEMBLY INSTRUCTION-CT495

A	B	C	D	E	F
24 PCS 	20 PCS 	4 PCS 	4 PCS 	4# 1 PC 	4 PCS 
G  4 PCS	I  4 PCS	J 5# 1 PC 	/		
1  1 PC	2  4 PCS	3  4 PCS	4  2 PCS	/	

1

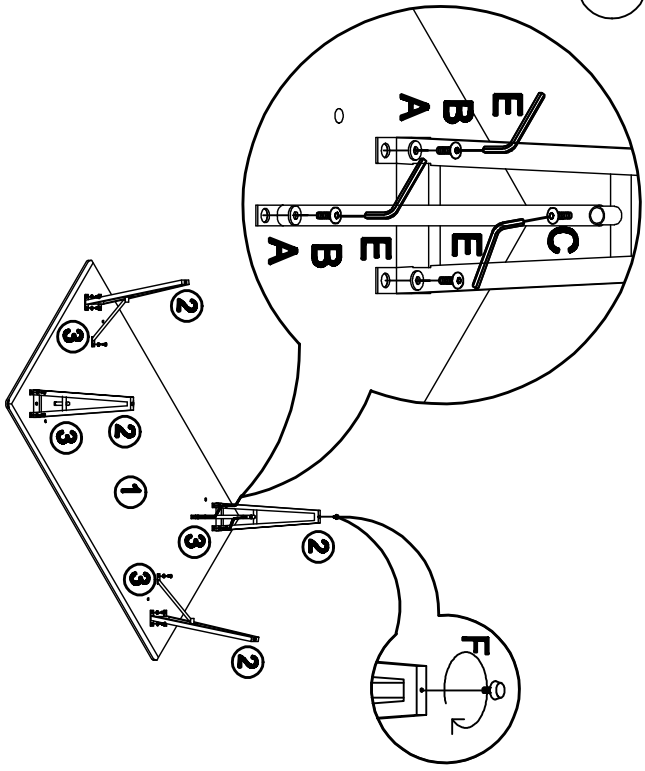

75%

2

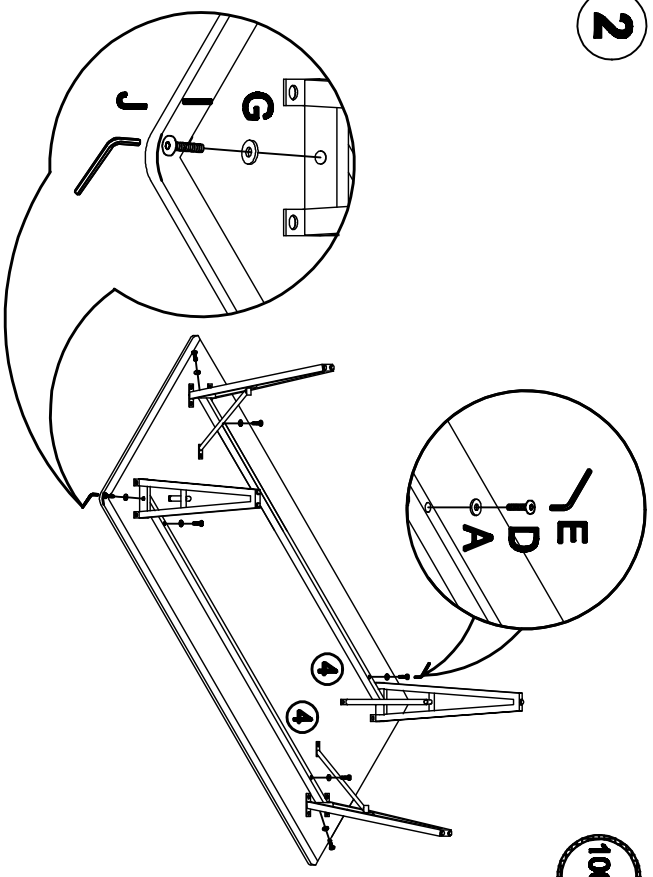

100%

