

2 ΧΡΟΝΙΑ ΕΓΓΥΗΣΗ

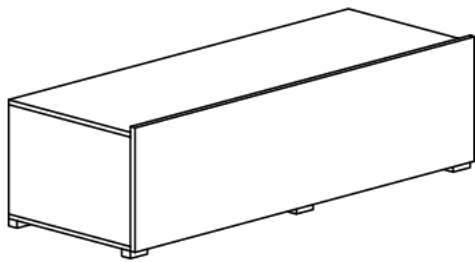



A	2x 373x400	1/1
B	373x320	1/1
C	2x 1200x400	1/1
D	393x1188	1/1
E	425x1197	1/1

12x 10174	12x Φ 8x30 10013	12x 50317	3x 40161	2x 50948	6x 50449	2x 51066
2x 10060	2x Φ 6/80 10021	12x Φ 4/35 10019	27x Φ 3,5/16 10001	 10033		

1

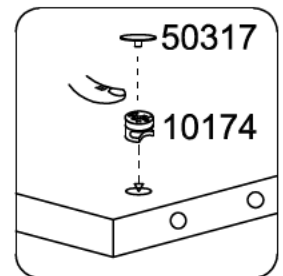
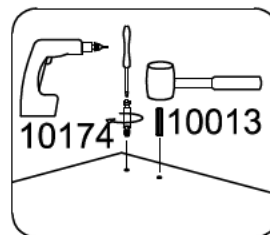
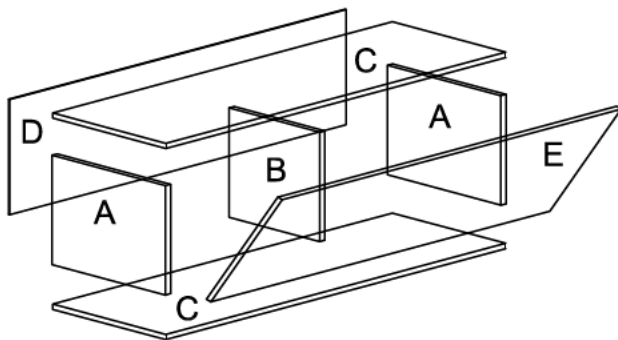

1.1

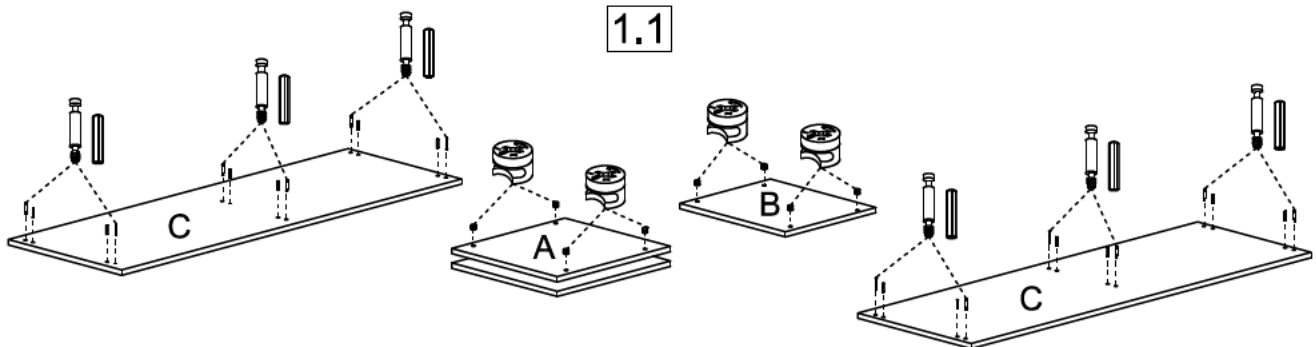

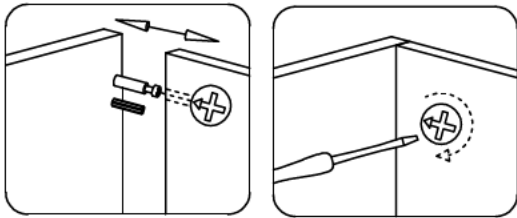

1.2

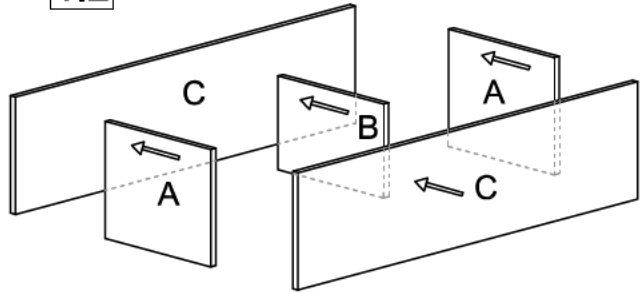

1.3

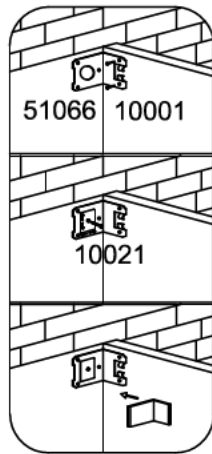
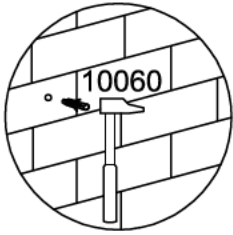
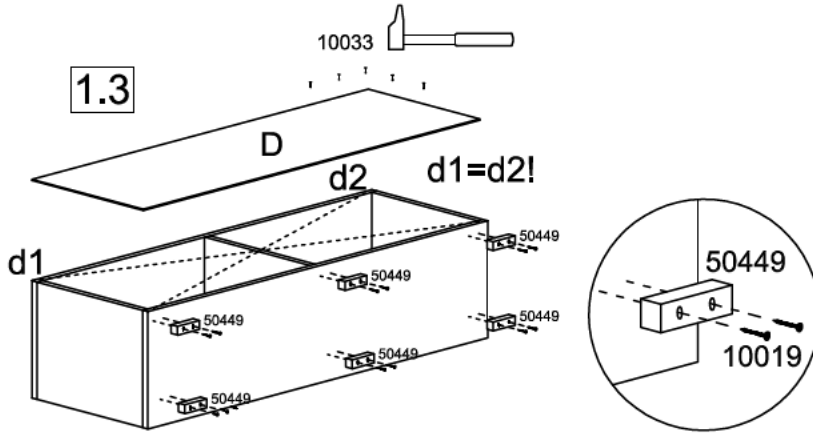

1.4

