

# ASSEMBLY INSTRUCTION

▽ PARTS\*QTY

## 7 ASSEMBLY PROGRAM

STEP1

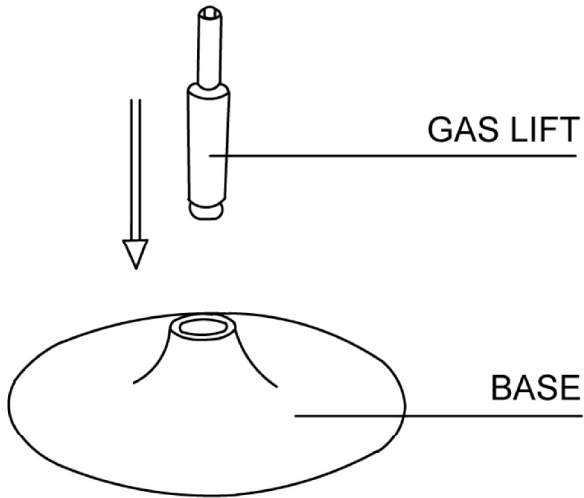

STEP2

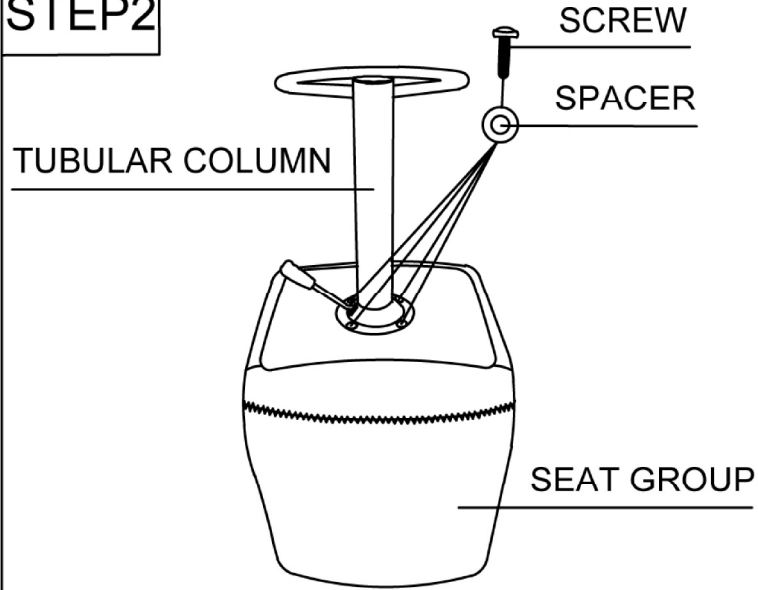



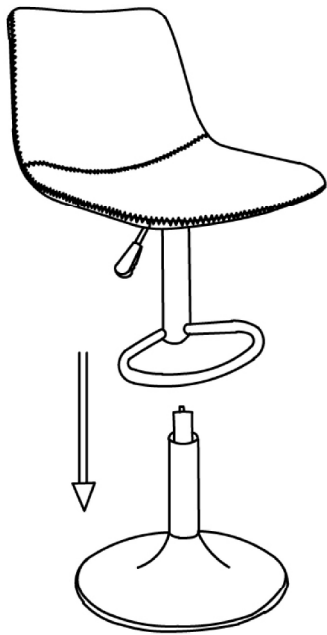

STEP3



FINISH

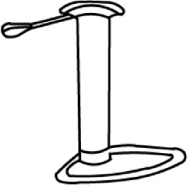
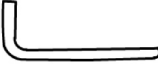
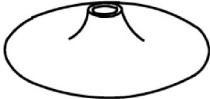

SEAT GROUPx1 	SPACER(M6X18mm) 
TUBULAR COLUMNx1 	SPANNERx1 
BASEx1 	
GAS LIFTx1 	
SCREW(M6X16mm)x4 