

A



16X

B



∅3.5*14

4X

C



∅3.5*35

4X

1

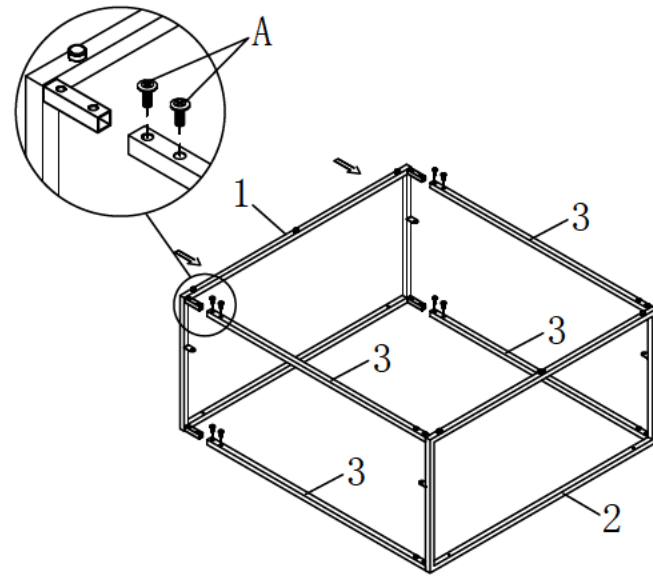

2

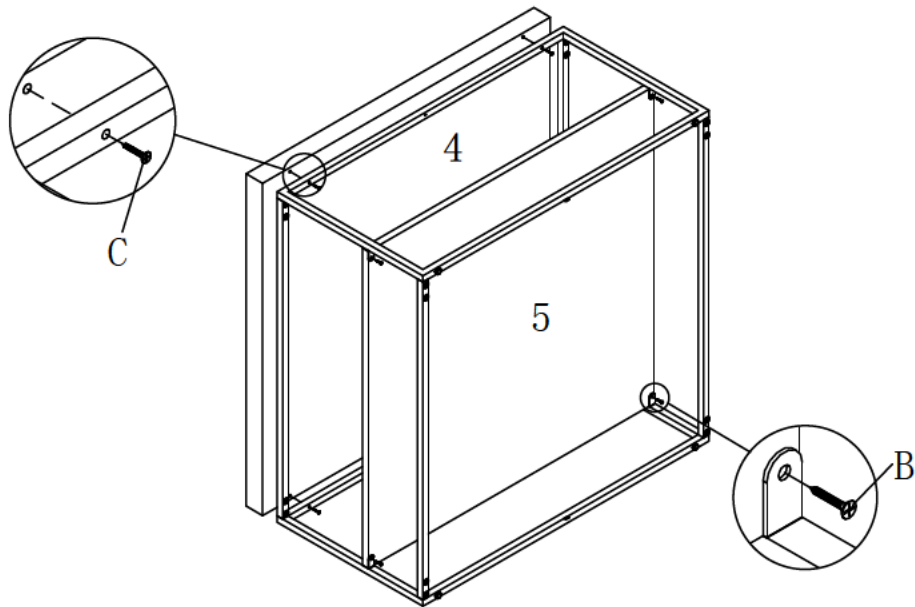

3

